

**BluE series**

12KTL-M1/15KTL-M1/20KTL-M2

---

**Grid-Connected Inverter**  
*Installation and Operation Manual*

# Contents

1. Introduction .....	3
1.1 Product Description .....	3
1.2 Unpacking inspection.....	4
1.3 Packaging .....	4
1.4 Optional Packaging .....	5
1.5 Inverter Storage .....	6
2. Safety Instructions .....	7
2.1 Safety Symbols .....	7
2.2 General Safety Instructions .....	7
2.3 Notice For Use.....	8
3. Overview .....	9
3.1 Front Panel Display .....	9
3.2 LED Status Indicator Lights .....	9
3.3 Keypad .....	10
3.4 LCD .....	10
4. Installation .....	11
4.1 Select Location for the Inverter .....	11
4.2 Mounting the Inverter.....	13
4.3 Electrical Connections .....	15
4.3.1 Connect PV side of inverter .....	15
4.3.2 Connect grid side of inverter .....	18
4.3.3 External ground connection .....	20
4.3.4 Max. overcurrent protection device (OCPD).....	21
4.3.5 Inverter monitoring connection .....	22
4.3.6 CT connections (optional) .....	23
4.3.7 DRED port connections(optional).....	24
5. Start & Stop .....	25
5.1 Start the Inverter .....	25
5.2 Stop the Inverter .....	25

## Contents

6.LCD Operation Menu.....	27
6.1 Initialization.....	27
6.2 Major cycle menuon .....	27
6.3 User interface.....	29
6.4 Setting.....	29
6.5 Inquiry.....	38
6.6 Statistics.....	40
7.Maintenance .....	42
8.Trouble shooting .....	42
9.Specifications .....	48
10.Quality Assurance .....	52
11.Contact Informaiton .....	53

## 01 Introduction

### 1.1 Product Description

The new generation of household three-phase series photovoltaic grid connected inverter converts the sun into electric energy through the inverter device, which is used by the power users. It adopts a new design and integrates various functional devices to adapt to various complex installation environments.

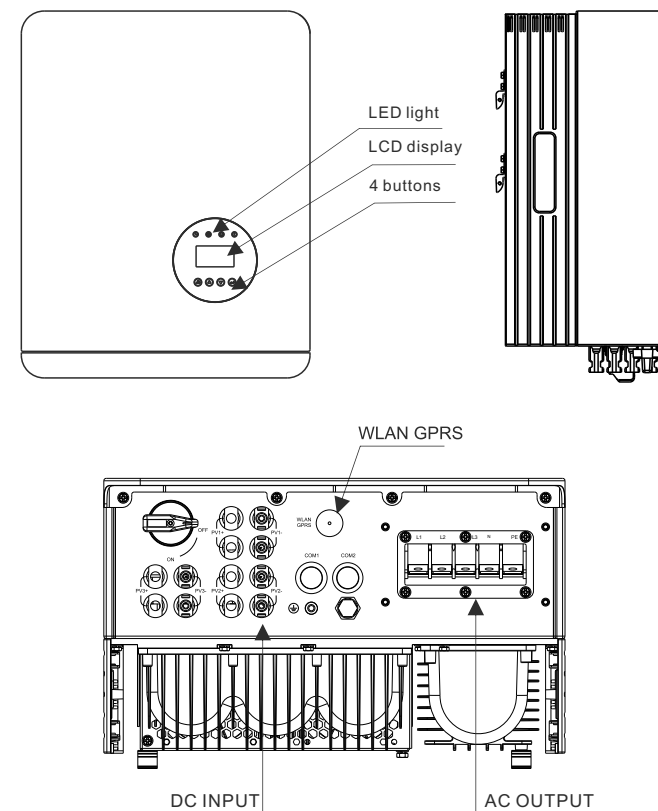

▲ Figure 1 Bottom side view

Object	Description	DVC class	Object	Description	DVC class
1	PV1, PV2	DVC C	2	COM2(CT)	DVC A
3	WLAN GPRS	DVC A	4	AC	DVC A

## 1.2 Unpacking Inspection

Before opening the inverter package, please check whether the outer package is damaged. After opening the package, please check whether the inverter appearance is damaged or lack of accessories. The placement of accessories is as follows:

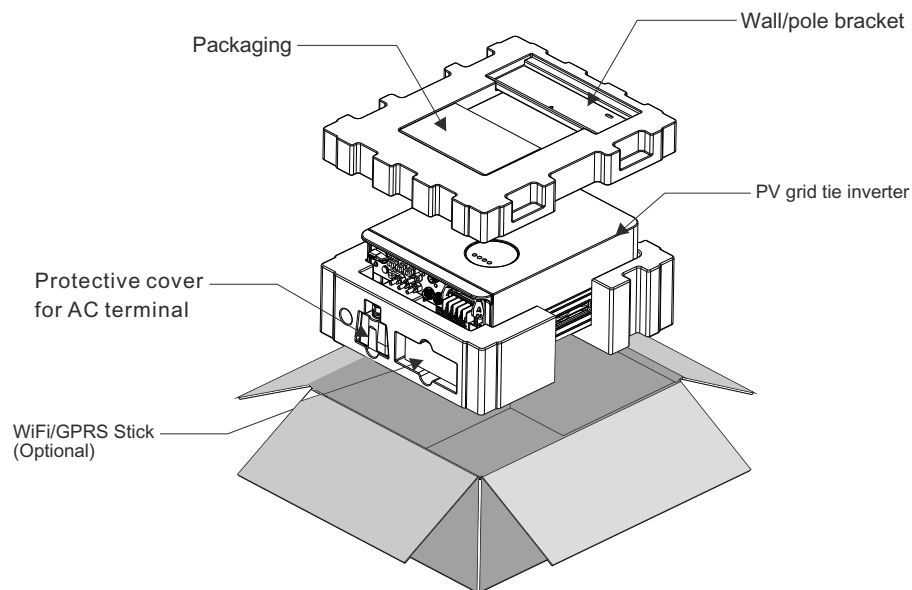

## 1.3 Packaging

When you receive the inverter, ensure that all the parts listed below are included:

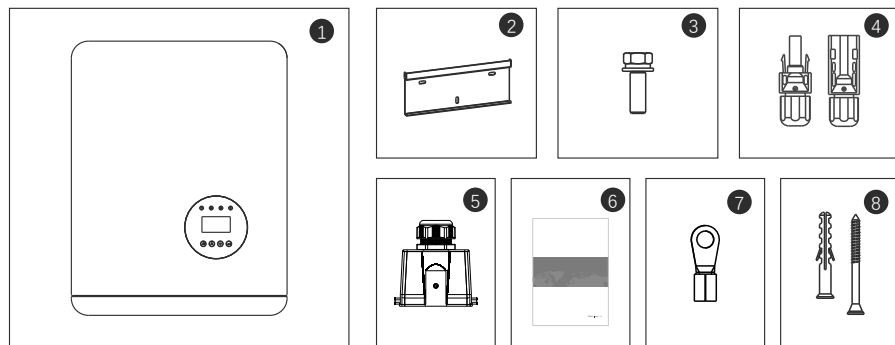

Part #	Description	Model	Number
1	PV grid tie inverter		1
2	Wall/pole bracket		1
3	Locking screws		6
4	PV connection terminal (+,-)	12KTL~20KTL	4
5	Protective cover for AC terminal		1
6	Manual		1
7	OT terminal		6
8	Self tapping screw and expansion pipe		3/3

## 1.4 Optional Packaging

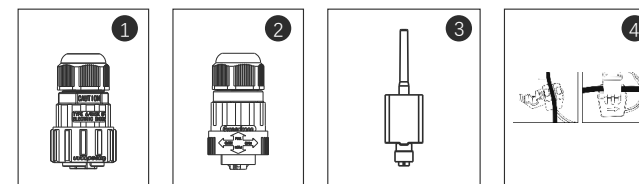

Part #	Description	Number
1	DRM connector	1
2	Meter 485 connector	1
3	WiFi/GPRS Stick	1
4	1x CT and com cable	1

## 1.5 Inverter Storage

Proper storage is required if the inverter is not installed immediately.

- Store the inverter in the original packing case .
- The storage temperature must be always between  $-40^{\circ}\text{C}$  and  $+70^{\circ}\text{C}$ , and the storage relative humidity must be always between 0 and 95%, non-condensing.
- In case of stacking storage, the number of stacking layers should never exceed the limit marked on the outer side of the packing case.

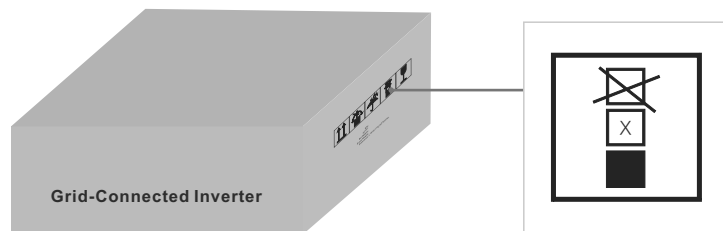

- The packing case should be upright.
- If the inverter has been stored more than half a year, the qualified personnel should thoroughly check and test it before using.

## 02 Safety Instructions

Improper use may result in potential electric shock hazards or burns. This manual contains important instructions that should be followed during installation and maintenance. Please read these instructions carefully before use and keep them for future reference. Contact the nearest hazardous waste disposal station when the products or components are discarded.

### 2.1 Safety Symbols

Safety symbols used in this manual, which highlight potential safety risks and important safety information, are listed as follows:

 **WARNING:**  
WARNING symbol indicates important safety instructions, which if not correctly followed, could result in serious injury or death.

 **NOTE:**  
NOTE symbol indicates important safety instructions, which if not correctly followed, could result in some damage or the destruction of the inverter.

 **CAUTION:**  
**CAUTION, RISK OF ELECTRIC SHOCK** symbol indicates important safety instructions, which if not correctly followed, could result in electric shock.



 **CAUTION:**  
**CAUTION, HOT SURFACE** symbol indicates safety instructions, which if not correctly followed, could result in burns.

### 2.2 General Safety Instructions

 **WARNING:**  
Only devices in compliance with SELV may be connected to the RS485 and USB interfaces.

 **WARNING:**  
Please don't connect PV array positive(+) or negative(-) to ground, it could cause serious damage to the inverter.

 **WARNING:**  
Electrical installations must be done in accordance with the local and national electrical safety standards.

  **WARNING:**  
Do not touch any inner live parts until 5 minutes after disconnection from the utility grid and the PV input.

**WARNING:**



To reduce the risk of fire, over-current protective devices (OCPD) are required for circuits connected to the Inverter. The DC OCPD shall be installed per local requirements. All photovoltaic source and output circuit conductors shall have disconnects that comply with the NEC Article 690, Part II.

**CAUTION:**



Risk of electric shock. Do not remove cover. There is no user serviceable parts inside. Refer servicing to qualified and accredited service technicians.

**CAUTION:**



The PV array (Solar panels) supplies a DC voltage when they are exposed to sunlight.

**CAUTION:**



Risk of electric shock from energy stored in capacitors of the Inverter. Do not remove cover for 5 minutes after disconnecting all power sources(service technician only). Warranty may be voided if the cover is removed without unauthorized. If the equipment is used in a manner not specified by the manufacturer, the protection provided by the equipment may be impaired.

**CAUTION:**



The surface temperature of the inverter can reach up to 75°C (167 F). To avoid risk of burns, do not touch the surface of the inverter while it is operating. Inverter must be installed out of the reach of children.



PV module used with inverter must have an IEC 61730 Class A rating.

### 2.3 Notice for use

The inverter has been constructed according to the applicable safety and technical guidelines. Use the inverter in installations that meet the following specifications only:

1. Permanent installation is required.
2. The electrical installation must meet all the applicable regulations and standards.
3. The inverter must be installed according to the instructions stated in this manual.
4. The inverter must be installed according to the correct technical specifications.
5. To startup the inverter, the Grid Supply Main Switch (AC) must be switched on, before the solar panel's DC isolator shall be switched on. To stop the inverter, the Grid Supply Main Switch (AC) must be switched off before the solar panel's DC isolator shall be switched off.

## 03 Over view

### 3.1 Front Panel Display

LCD display is Optional.

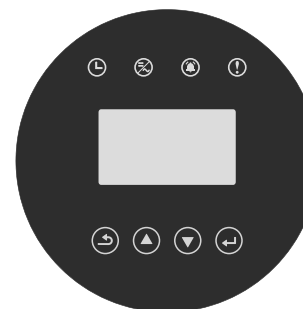

▲ Figure 3.1 Front Panel Display

### 3.2 LED Status Indicator Light

The LED status indicator can display red and green. When the indicator light is on, it indicates that there is power. When the indicator light is red, it indicates the alarm state; when the indicator light is green, it indicates the operation state.

Light	Status	Description
	ON	CHECKING: The device is checking.
	ON	Generating: The device is generating the power.
	Twinkle	Generating: Flashing indicates that the inverter is being connected to the power grid.
	Twinkle	Alarm: The inverter has an alarm signal.
	ON	Fault: A fault occurs and the device is not generating.

▲ Table 3.1 status indicator

### 3.3 Keypad (Optional)

There are four keys in the front panel of the Inverter from left to right: ESC, UP, DOWN and ENTER keys. The keypad is used for:

- Scrolling through the displayed options (the UP and DOWN keys);
- Access to modify the adjustable settings (the ESC and ENTER keys).

### 3.4 LCD (Optional)

The four-line Liquid Crystal Display (LCD) is located on the front panel of the Inverter, which shows the following information:

- Inverter operation status and data;
- Service messages for operator;
- Alarm messages and fault indications.

You can also get information via WiFi / GPRS.

## 04 Installation

### 4.1 Select a Location for the Inverter

To select a location for the inverter, the following criteria should be considered:

- Do not install in small closed spaces where air can not circulate freely. To avoid overheating, always make sure the flow of air around the inverter is not blocked.
- Exposure to direct sunlight will increase the operational temperature of the inverter and may cause output power limiting. Kstar recommends inverter installed to avoid direct sunlight or raining.
- To avoid overheating ambient air temperature must be considered when choosing the inverter installation location. Kstar recommends using a sun shade minimizing direct sunlight when the ambient air temperature around the unit exceeds 104°F/40°C.



▲ Figure 4.1 Recommended Installation locations

- Install on a wall or strong structure capable of bearing the weight.
- Install vertically with a maximum incline of  $\pm 5^\circ$ . If the mounted inverter is tilted to an angle greater than the maximum noted, heat dissipation can be inhibited, and may result in less than expected output power.
- When 1 or more inverters are installed in one location, a minimum 300mm clearance should be kept between each inverter or other object (if a canopy is added, a distance of 50cm must also be kept). The bottom of the inverter should be 500mm clearance to the ground.

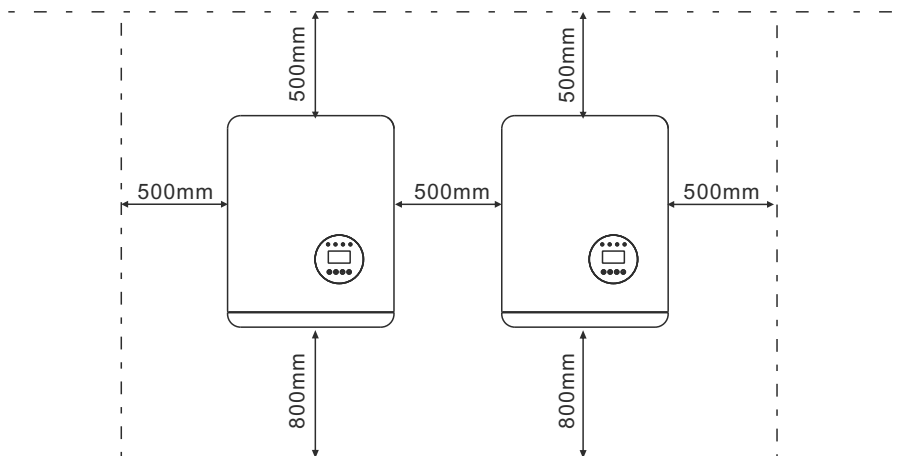

▲ Figure 4.2 Inverter Mounting clearance

- Visibility of the LED status indicator lights and the LCD located at the front panel of the inverter should be considered.
- Adequate ventilation must be provided if the inverter is to be installed in a confined space.



**NOTE:**

Nothing should be stored on or placed against the inverter. It is not allowed to lay the machine horizontally for a long time, which will affect the heat dissipation.

## 4.2 Mounting the Inverter

Dimensions of wall bracket:

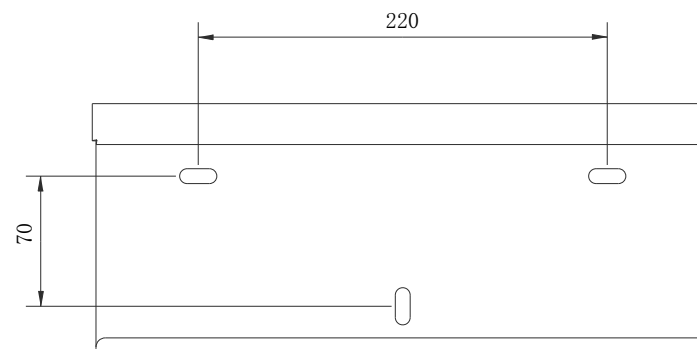

▲ Figure 4.3 Inverter wall mounting

Please see Figure 4.4 and Figure 4.5 for instruction on mounting the inverter.

The inverter shall be mounted vertically. The steps to mount the inverter are listed below:  
 1. According to Figure 4.2, select the bracket mounting height and mark the mounting hole. After marking, punch the hole according to the mark. For brick wall drilling, expansion bolts shall be suitable for fixing.

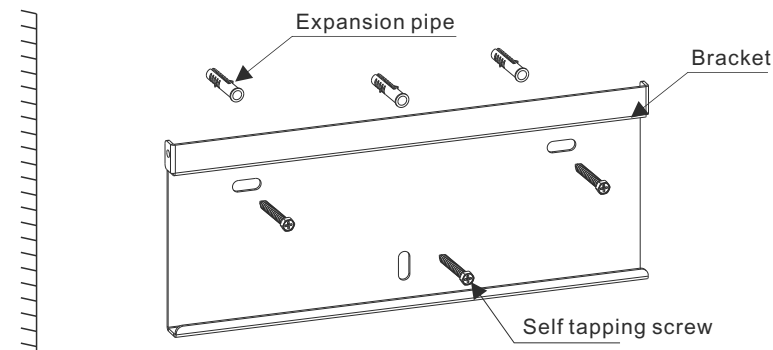

▲ Figure 4.4 Inverter wall mounting

2. Make sure that the bracket is horizontal and the mounting hole (as shown in Figure 4.4) is correctly marked, and drive the expansion pipe into the wall with a hammer.
3. Use the suitable screws to fix the bracket to the wall.

**WARNING:**

The inverter must be mounted vertically.

4. Lift up the inverter (be careful to avoid body strain), and align the back bracket on the inverter with the convex section of the mounting bracket. Hang the inverter on the mounting bracket and make sure the inverter is secure (see Figure 4.5).

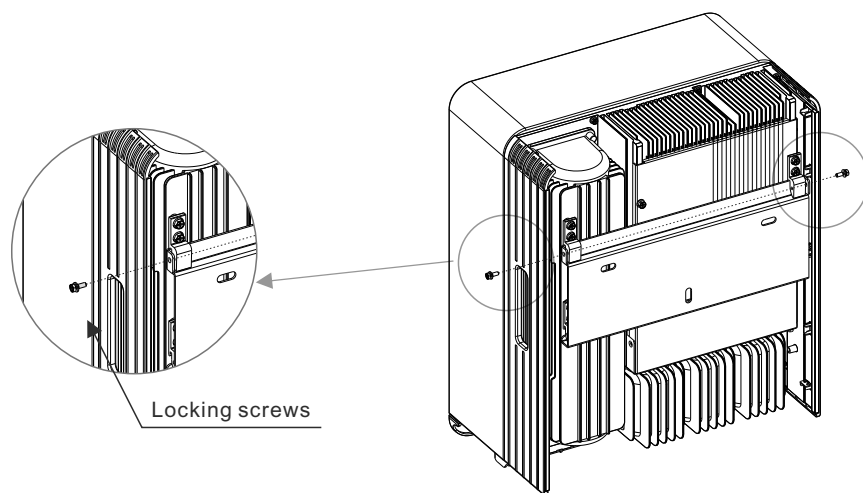

▲ Figure 4.5 Wall Mount Bracket

5. Use M4 screws in accessory to lock the inverter to the mount bracket.

## 4.3 Electrical Connections

### 4.3.1 Connect PV side of inverter

The electrical connection of the inverter must follow the steps listed below:

1. Switch the Grid Supply Main Switch (AC) OFF.
2. Switch the DC Isolator OFF.
3. Assemble PV input connector to the Inverter.



Check whether the polarity of the connecting cable of the photovoltaic string is correct, and ensure that the open circuit voltage under any condition does not exceed the upper limit of the inverter input value of 1100V.



Please don't connect PV array positive or negative pole to the ground, it could cause serious damages to the inverter.



Before connection, please make sure the polarity of the output voltage of PV array matches the "PV+" and "PV-" symbols.

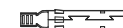
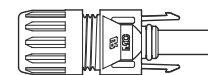

▲ Figure 4.6 PV+ Connector

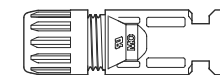

▲ Figure 4.7 PV- Connector



Check the positive and negative polarity of the PV strings, and connect the PV connectors to the right terminals. Serious damages to the inverter and connector over temperature may occur.

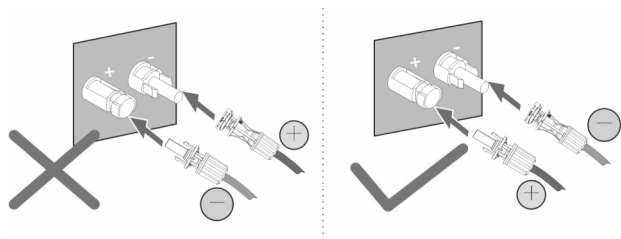

Please use approved DC cable for PV system.

Cable type	Cross section	
	Range	Recommended value
Industry generic PV cable(model:PV1-F)	4.0-6.0 (12-10AWG)	4.0 (12AWG)

▲ Table 4.1 DC cable

The steps to assemble the DC connectors are listed as follows:

1.Strip off the DC wire for about 7mm, Disassemble the connector cap nut.

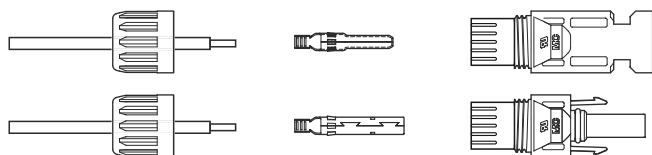

▲ Figure 4.8 Disassemble the Connector Cap nut

2.Insert the wire into the connector cap nut and contact pin.

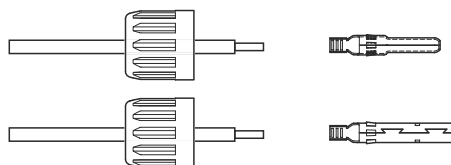

▲ Figure 4.9 Insert the Wire into the Connector Cap nut and contact pin

3.Crimp the contact pin to the wire using a proper wire crimper.

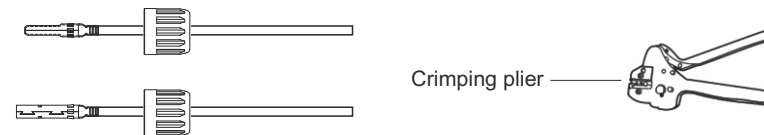

▲ Figure 4.10 Crimp the contact pin to the wire

4.Insert the contact pin to the top part of the connector and screw up the cap nut to the top part of the connector.

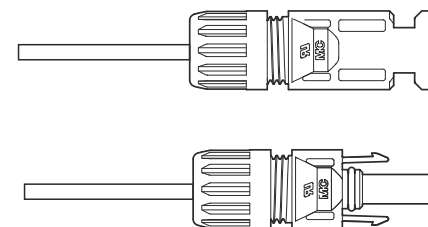

▲ Figure 4.11 Connector with Cap nut Screwed on

5.Then connect the DC connectors to the inverter. Small click will confirm connection.

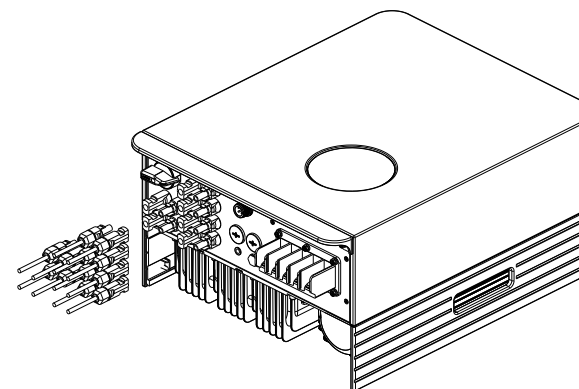

▲ Figure 4.12 Connect the DC Connectors to the Inverter

### 4.3.2 Connection of AC output

For all AC connections, 4-10mm<sup>2</sup> 105 XJ cable is required to be used. Please make sure the resistance of cable is lower than 1 ohm. If the wire is longer than 20m, it's recommended to use 10mm<sup>2</sup> cable.

**WARNING:**



There are "L1,L2,L3" "N" "PE" symbols marked inside the connector, the Line wire of grid must be connected to "L1,L2,L3" terminal; the Neutral wire of grid must be connected to "N" terminal; the Earth of grid must be connected to "PE"

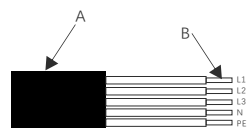

Object	Description	Value
A	External diameter	10mm
B	Copper conductor cross-section	4mm <sup>2</sup>

Model	Cross section Range
12KTL~20KTL	16-25mm <sup>2</sup>

▲ Table 4.2 AC cable

Connect grid side of inverter

- 1.First check the AC circuit breaker and disconnect the inverter and the grid
2. Use wire stripper to peel the outer surface of the cable for about 50 mm, and then peel off the wire skin of 5 wires, as shown in the figure below;

Step 1.Strip the protection layer and insulation layer by specific length,as described in the figure below.

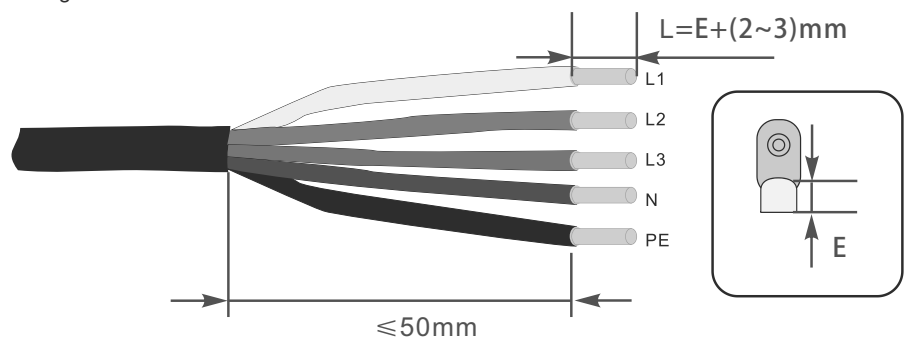

Step 2. Make the cable and crimp the OT terminal.

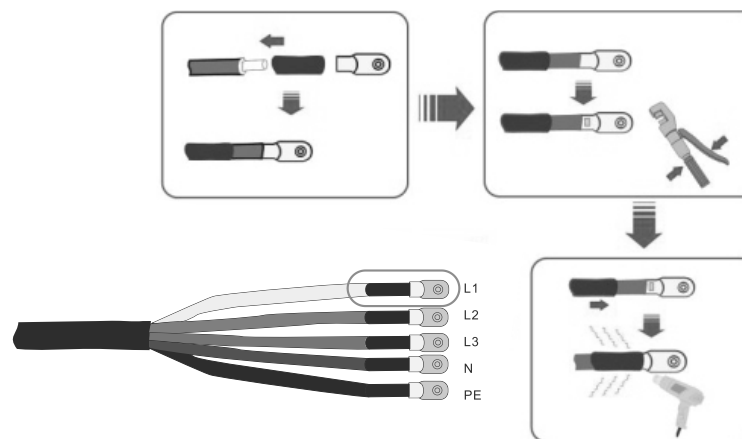

Step 3.Follow the instruction and secure the cable to corresponding terminals.

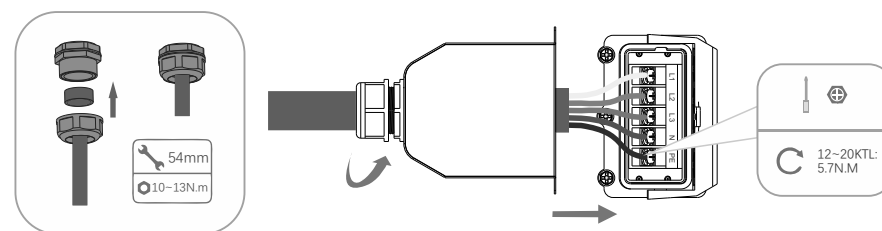

Step 4.Secure the junction box,fasten the buckle, and secure it with screw.

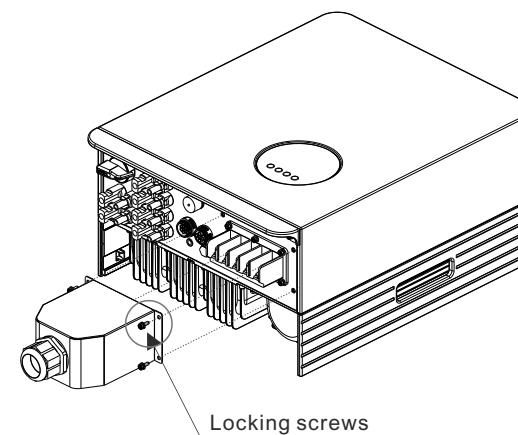

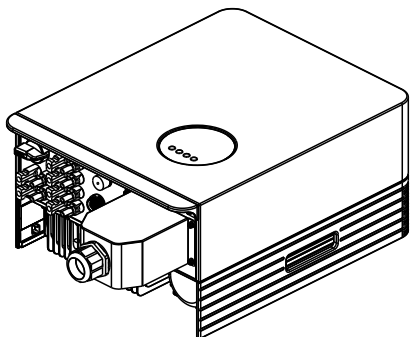

▲ Figure 4.18 Connect the AC Connector to the Inverter

### 4.3.3 External ground connection

The external ground connection is located on the bottom side of the inverter. Prepare OT terminal, tighten the screw. The machine comes with it. Use appropriate tools to screw out the screw and crimp the lug to the terminal.

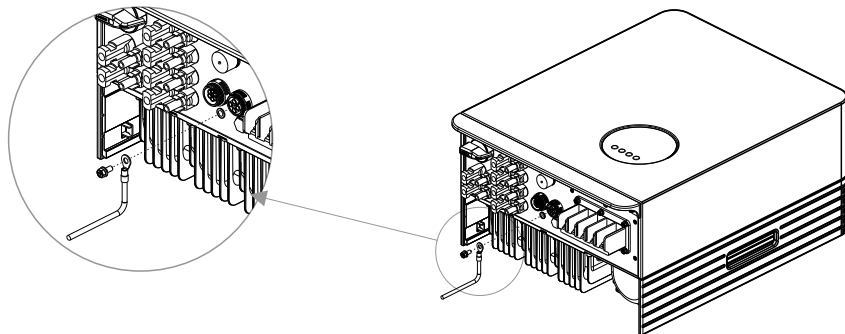

▲ Figure4.19 Connect the external grounding conductor



Note:

When earth fault occurs , the machine cannot be connected to the grid, the LED red light is on, and the LCD displays the fault code F07 until the fault is resolved.

### 4.3.4 Max, over current protection device (OCPD)

To protect the inverter's PV and AC grid connection conductors, Kstar recommends installing breakers that will protect against overcurrent. The following table defines OCPD ratings for the inverters.

Inverter	Rated output voltage(V)	Rated output current (A)	Current for protection device (A)
BluE-12KTL-M1	400	31.5	40
BluE-15KTL-M1	400	39.3	50
BluE-20KTL-M2	400	52.5	70

▲ Table 4.3 OCPD level of power grid

Inverter	Rated input voltage(V)	Max. input current (A)	Current for protection device (A)
BluE-12KTL-M1	370	30	50
BluE-15KTL-M1	370	30	50
BluE-20KTL-M2	370	30	50

▲ Table 4.4 PV OCPD ratings

### 4.3.5 Inverter monitoring connection

The inverter can be monitored via Wi-Fi or GPRS. All BluE communication devices are optional. For connection instructions, please refer to the BluE Monitoring Device installation manuals.

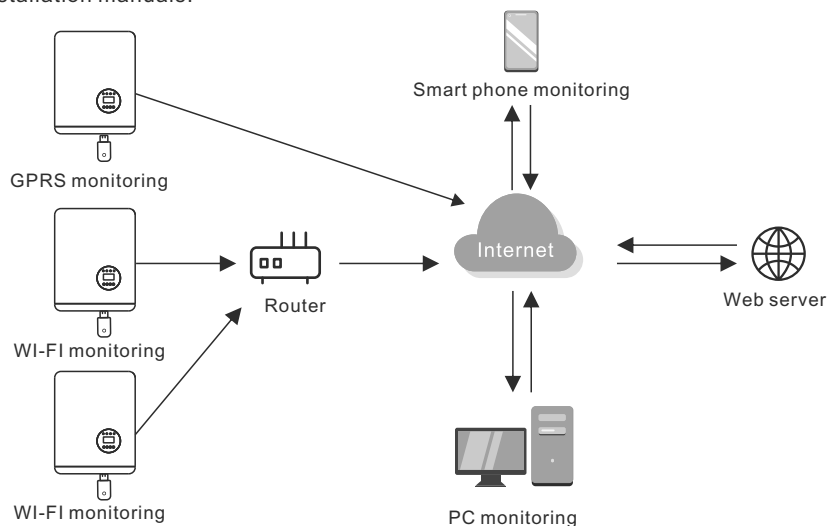

▲ Figure 4.20 Communication function

The inverter is equipped with standard RS485 and WLAN/GPRS communication ports, and the RS485 communication port is mainly used for the software upgrade, WLAN/GPRS communication port is for inverter wireless monitoring.

Pin	Description	Pin	Description
1	VCC	3	485A
2	GND	4	485B

▲ Table 4.5

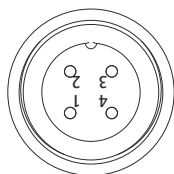

▲ Figure 4.21 Inverter WLAN/GPRS port

### 4.3.6 Meter connections(optional)

This inverter has integrated export limitation functionality. To use this function, a CT must be installed, if use the CT, please reference below picture. The CT should be fitted around the live conductor on the grid side of the main incoming consumer unit. Use the directional flow indication arrow on the CT to ensure it is fitted in the correct orientation. The arrow should be pointing towards the grid, not the load.

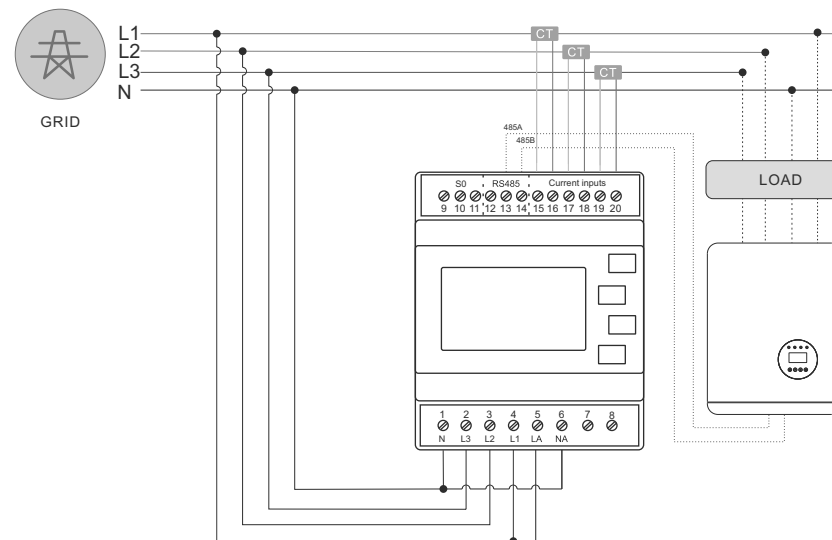

▲ Figure 4.22 Schematic diagram of connection between inverter and meter (Inverter on the right side of load)

Pin	Description	Pin	Description
1	NC	3	485A positive electrode
2	NC	4	485B negative pole

▲ Table 4.6

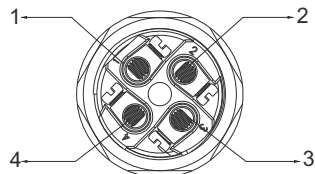

Please follow below figure to assemble CT connector.

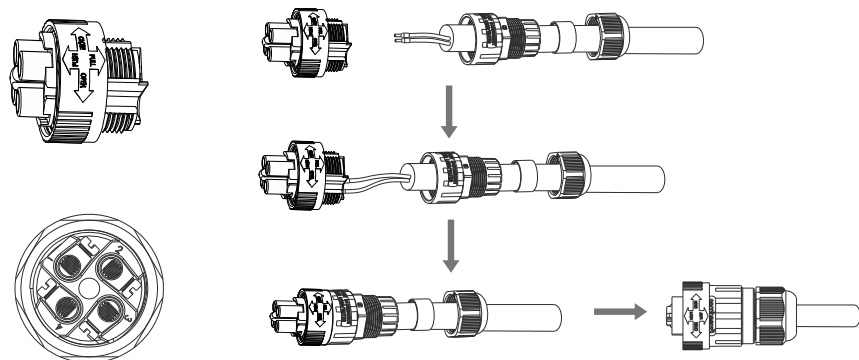

▲ Figure 4.23 DRM connector

### 4.3.7 DRED port connections(optional)

DRED means demand response enable device. The AS/NZS 4777.2:2015 required inverter need to support demand response mode(DRM). This function is for inverter that comply with AS/NZS 4777.2:2015 standard. Inverter is fully comply with all DRM. A 6P terminal is used for DRM connection.

Pin	Description	Pin	Description
1	DRM 0	4	DRM 7
2	DRM 5	5	DRM 8
3	DRM 6	6	Com

▲ Table 4.7

Please follow below figure to assemble DRM connector.

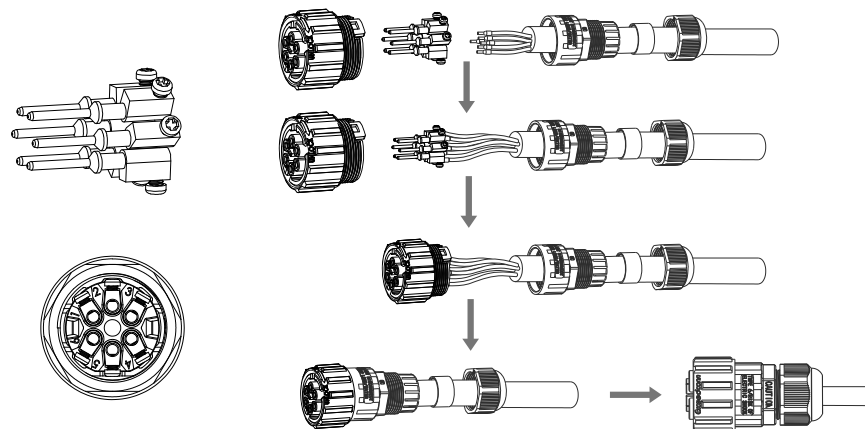

▲ Figure 4.24 DRM connector

## 05 Start&Stop

### 5.1 Start the Inverter

To start up the Inverter, it is important that the following steps are strictly followed:

1. Switch the grid supply main Switch (AC) ON first.
2. Switch the DC switch ON. If the voltage of PV arrays are higher than start up voltage, the inverter will turn on. The LED status indicator will light.
3. When both the DC and the AC sides supply to the inverter, it will be ready to generate power. Initially, the inverter will check both its internal parameters and the parameters of the AC grid, to ensure that they are within the acceptable limits. At the same time, the green LED will flash and the LCD displays the information of INITIALIZING.
4. After 60-300 seconds (depending on local requirement), the inverter will start to generate power. The green LED will be on continually and the LCD displays GENERATING.



**WARNING:**

Do not touch the surface when the inverter is operating. It may be hot and cause burns.

### 5.2 Stop the Inverter

To stop the Inverter, the following steps must be strictly followed:

1. Switch the Supply Main Switch (AC) OFF.
2. Wait 30 seconds. Switch the DC Switch OFF. All the LEDs of the inverter will be off in one minute.

## 06 LCD Operation Menu

### 6.1 Initialization

Interface	Explanation
	After starting-up of inverter, LCD will firstly enter this interface, and deliver parameters required by operation of the machine to DSP.

### 6.2 Major cycle menu-on

After initialization, LCD will enter a major cycle menu to display running information of the inverter in a circulating mode, including 10 interfaces for network voltage, frequency of electric network, etc. Time for automatic switch-over between interfaces is 3 seconds, also the interfaces can be switched manually by pressing UP or DOWN buttons, if you want to fix at a certain interface, press ENTER to lock this interface, after successful locking, a lock icon will occur at upper right corner of this interface, press ENTER button again, this interface will be unlocked, and the menu will continue to display in a circulating mode.

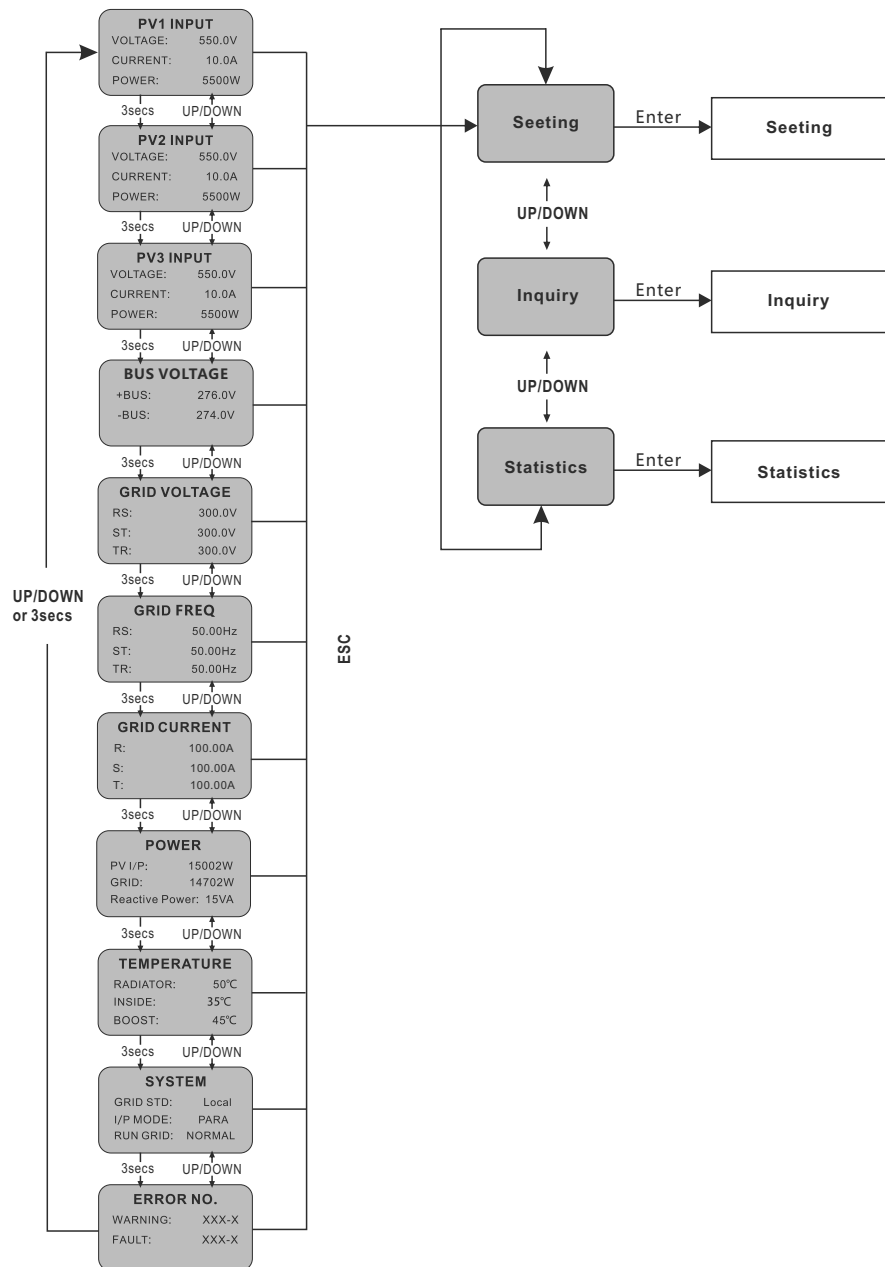

Figure 1: Interface of recycling display

When the menu is in an automatic cycling display mode, if error (fault) or warning alarm occurs, it will skip into system interface immediately and lock to it, and this will make convenience for the user to determine its cause based on codes on the interface. After disappearing of error (fault) or warning alarm, the menu will return to automatic circulating mode. Press ESC button to exit major circulating menu interface and enter user interface (refer to 6.3).

### 6.3 User interface

Interface	Explanation
<pre> -----USER----- -&gt;1:Setting   2:Inquire   3:Statistics                     </pre>	Select corresponding options by pressing UP or DOWN button, enter "setting", "inquiry" and "statistics" menus by pressing ENTER button. Press ESC to return major circulating menu.

### 6.4 Setting

Interface	Explanation
<pre> ---PASSWORD--- Input:XXXXX                     </pre>	After entering into the setup interface, the system will prompt to input password, the default password is "0000", and this password can be altered Password setting menu (refer to 6.4.12); press UP/DOWN to increase or decrease the input figure, press ENTER button to move the cursor backwards, press ESC button to move the cursor forward.

After successful input of password, it will enter setting option interface. Press UP/DOWN to move corresponding options, and enter the selected menu by pressing ENTER button; press ESC button to return back the user interface (refer to 6.3), there are 15 options in total, including input mode, grid std, remote ctrl, run setting, 485 address, baud rate, protocol, language, backlight, date/time, clear rec, password, maintenance, fctry reset, array detec.

### 6.4.1 Input mode

Interface	Explanation
<pre> --- INPUT MODE --- →1:INDEPENDENT  2:PARALLEL           </pre>	<p>Press UP/DOWN button to move corresponding option. Then confirm the selected option and enter interface of please restart (refer to 6.4.4.11) by pressing ENTER button. Press ESC button to cancel choice and return back setup interface (refer to 6.4). Default option is independent.</p>

### 6.4.2 Standard for electric network

Interface	Explanation
<pre> --GRID STD-- →1:China  2:Germany  3:Australia  4:Italy  5:Spain  6:U.K.           </pre>	<p>Press UP/DOWN button to move corresponding options, including China, Germany, Australia, Italy, Spain, U.K; with 16 kinds in total. Then confirm the selected option and enter interface of please restart (refer to 6.4.4.11) by pressing ENTER button. Press ESC button to cancel choice and return back setup interface (refer to 6.4).</p>

### 6.4.3 Remote CTRL

Interface	Explanation
<pre> ----REMOTE CTRL---- →1:DISABLE  2:ENABLE           </pre>	<p>Press UP/DOWN button to move corresponding options. Then confirm the selected option and return back setup interface (refer to 6.4) by pressing ENTER button. Press ESC to cancel choice and return back setup interface (refer to 6.4). Default option is disability.</p>

### 6.4.4 Working parameters

Interface	Explanation
<pre> -- RUN SETTING-- →1: VPV-START  2: DELAY-START  3: VAC-MIN           </pre>	<p>Press UP/DOWN button to move corresponding options, press ENTER to enter into the selected menu; return back setup interface (refer to 6.4) by pressing ESC, there are 10 options in total, including VPV-START, DELAY-START, VAC-MIN, VAC-MAX, FAC-MIN, FAC-MAX, ACTIVE POWER, REACT POWER, FREQ POWER and V LOAD.</p>

### 6.4.4.1 Starting-up voltage

Interface	Explanation
<pre> ---START-UP VOLT--- INPUT:200V UNIT: V           </pre>	<p>Press UP/DOWN to increase or decrease the input figure, move the cursor backwards and confirm completion of input as well as enter into interface of please restart (refer to 6.4.4.11) by pressing ENTER button, press ESC to move the cursor forward and return back working interface (refer to 6.4.4); the input figure is 200, default is 200.</p>

### 6.4.4.2 Starting-up delay time

Interface	Explanation
<pre> -- START-UP DELAY-- INPUT: 60 UNIT: SEC           </pre>	<p>Press UP/DOWN to increase or decrease the input figure, confirm input and enter into interface of please restart (refer to 6.4.4.11) by pressing ENTER button; press ESC to cancel input and return back working interface (refer to 6.4.4), input figure is between 60 and 300. This parameter is changed by grid standards.</p>

### 6.4.4.3 Low voltage of electric network

Interface	Explanation
<pre> --GRID VOLT LOW-- INPUT: 450 UNIT: V           </pre>	<p>Press UP/DOWN to increase or decrease the input figure, confirm input and enter into interface of please restart (refer to 7.4.4.11) by pressing ENTER button; press ESC to cancel input and return back working interface (refer to 7.4.4), input figure is between 450 and 490. This parameter is changed by grid standards.</p>

### 6.4.4.4 High voltage of electric network

Interface	Explanation
<pre> -- GRID VOLT HIGH -- INPUT:550 UNIT:V           </pre>	<p>Press UP/DOWN to increase or decrease the input figure, confirm input and enter into interface of please restart (refer to 6.4.4.11) by pressing ENTER button; press ESC to cancel input and return back working interface (refer to 6.4.4), the input figure is between 510 and 550. This parameter is changed by grid standards.</p>

### 6.4.4.5 Low frequency of electric network

Interface	Explanation
<pre>-- GRID FREQ LOW-- INPUT:49.5 UNIT:Hz</pre>	<p>Press UP/DOWN to increase or decrease the input figure, confirm input and enter into interface of please restart (refer to 6.4.4.11) by pressing ENTER button; press ESC to cancel input and return back working interface (refer to 6.4.4), the input figure is between 45.0 and 49.8. This parameter is changed by grid standards.</p>

### 6.4.4.6 High frequency of electric network

Interface	Explanation
<pre>-- GRID FREQ HIGH-- INPUT:50.5 UNIT:Hz</pre>	<p>Press UP/DOWN to increase or decrease the input figure, confirm input and enter into interface of please restart (refer to 6.4.4.11) by pressing ENTER button; press ESC to cancel input and return back working interface (refer to 6.4.4), the input figure is between 50.2 and 55. This parameter is changed by grid standards.</p>

### 6.4.4.7 Active power

Interface	Explanation
<pre>-- ACTIVE POWER -- →1:PERCENT SET 2:VALUE SET</pre>	<p>Press UP/DOWN to move corresponding options, and enter the selected menu by pressing ENTER button; press ESC button to return back working interface (refer to 6.4.4)</p>

#### 6.4.4.7.1 Power limit

Interface	Explanation
<pre>----POWER LIMIT---- INPUT: 019 %</pre>	<p>Press UP/DOWN to increase or decrease the input figure, confirm input and enter into interface of Active power (refer to 6.4.4.7) by pressing ENTER button; press ESC to cancel input and return back Active power (refer to 6.4.4.7), the input figure is between 0 and 100,100% corresponds to 1.1 times of rated power output.</p>

### 6.4.4.7.2 Power Value

Interface	Explanation
<pre>-- POWER VALUE -- INPUT:066KW</pre>	<p>Press UP/DOWN to increase or decrease the input figure, confirm input and enter into interface of Active power (refer to 6.4.4.7) by pressing ENTER button; press ESC to cancel input and return back Active power (refer to 6.4.4.7), the input figure is between 0and Pmax.</p>

### 6.4.4.8 Reactive power

Interface	Explanation
<pre>-- RE-POWER SET -- →1:RE-POWER CTL 2:POWER FACTOR 3:PERCENT SET</pre>	<p>Press UP/DOWN to move corresponding options, and enter the selected menu by pressing ENTER button; press ESC button to return back working interface (refer to 6.4.4)</p>

#### 6.4.4.8.1 RE-POWER CTL

Interface	Explanation
<pre>--RE-POWER CTL-- →1:POWER FACTOR 2:REACT POWER 3:QV WAVE</pre>	<p>Press UP/DOWN button to move corresponding options. And confirm selected option and return back the Reactive power by pressing ENTER button (refer to 6.4.4.8), press ESC button to cancel choice and return back Reactive power (refer to 6.4.4.8);</p>

#### 6.4.4.8.2 Power factor

Interface	Explanation
<pre>--POWER FACTOR-- INPUT:0.000</pre>	<p>Press UP/DOWN to increase or decrease the input figure, confirm input and return back Reactive power (refer to 6.4.4.8) by pressing ENTER button, press ESC button to cancel input and return back Reactive power (refer to 6.4.4.8); The default value is 1, and the range can be set from 0.8 to 1.2, where 0.8 means lag 0.8 and 1.2 means lead 0.8.</p>

### 6.4.4.8.3 Reactive power

Interface	Explanation
<pre> -REACTIVE POWER- INPUT : -26%                     </pre>	<p>Press UP/DOWN to increase or decrease the input figure, confirm input and return back Reactive power (refer to 6.4.4.8) by pressing ENTER button, press ESC button to cancel input and return back Reactive power (refer to 6.4.4.8); the input numerical value is between -60and +60.</p>

### 6.4.4.9 Over frequency derating

Interface	Explanation
<pre> ----FREQ POWER---- →1.FUNC ENB  2.THRESHOLD                     </pre>	<p>Press UP/DOWN button to move corresponding options, press ENTER to enter into the selected menu; return back working interface (refer to 6.4.4) by pressing ESC, there are 2 options in total, including function enable and frequency threshold.</p>

### 6.4.4.9.1 Over frequency derating enable

Interface	Explanation
<pre> --FREQ POWER-- →1.ENABLE  2.DISABLE                     </pre>	<p>Press UP/DOWN button to move corresponding options, press ENTER to enter into the Over frequency derating interface (refer to 6.4.4.9); return back Over frequency derating interface (refer to 6.4.4.9) by pressing ESC, there are 2 options in total, including enable and disable.</p>

### 6.4.4.9.2 Frequency threshold

Interface	Explanation
<pre> ----THRESHOLD---- INPUT : 65.0 UNIT : Hz                     </pre>	<p>Press UP/DOWN to increase or decrease the input figure, confirm input and enter into interface of Over frequency derating interface (refer to 6.4.4.9) by pressing ENTER button; press ESC to cancel input and return back Over frequency derating interface (refer to 6.4.4.9).the input numerical value is between 50.2 and 65.0.</p>

### 6.4.4.10 Over voltage derating

Interface	Explanation
<pre> --- V LOAD --- →1.ENABLE  2.DISABLE                     </pre>	<p>Press UP/DOWN button to move corresponding options, press ENTER to enter into the working interface (refer to 6.4.4); return back working interface (refer to 6.4.4) by pressing ESC, there are 2 options in total, including enable and disable. Overvoltage threshold setting, 242 ~ 270V.</p>

### 6.4.4.11 Please restart

Interface	Explanation
<pre> Please Restart!                     </pre>	<p>A prompt that it is required to start the machine once again, so that the setup relevant to working will be effective, and it will return back working interface (refer to 6.4.4) within 2 seconds.</p>

### 6.4.5 485 address

Interface	Explanation
<pre> ---485 ADDRESS--- INPUT:1                     </pre>	<p>Press UP/DOWN to increase or decrease the input figure, confirm input and return back setup interface (refer to 6.4) by pressing ENTER button, press ESC button to cancel input and return back setup interface (refer to 6.4); the input numerical value is between 1 and 64.</p>

### 6.4.6 485 baudrate

Interface	Explanation
<pre> -----SELECT----- →1:2400 bps  2:4800 bps  3:9600 bps                     </pre>	<p>Press UP/DOWN button to move corresponding options. And confirm selected option and return back the setup interface by pressing ENTER button (refer to 6.4), press ESC button to cancel choice and return back setup interface (refer to 6.4); options include 2400, 4800, 9600 and 19200, with 4 in total,Default is 9600.</p>

### 6.4.7 485 protocol

Interface	Explanation
<pre> ----SELECT---- →1: MODBUS   2: SOLAR RTU           </pre>	<p>Press UP/DOWN button to move corresponding options. And confirm selected option and return back the setup interface by pressing ENTER button (refer to 6.4), press ESC button to cancel choice and return back setup interface (refer to 6.4);</p>

### 6.4.8 Display language

Interface	Explanation
<pre> ---Display language--- →1: 中文   2: ENGLISH   3: DEUTSCH           </pre>	<p>Press UP/DOWN button to move corresponding options. And confirm selected option and enter into the setup interface (refer to 6.4) by pressing ENTER button, press ESC button to cancel choice and return back setup interface (refer to 6.4).</p>

### 6.4.9 LCD backlight

Interface	Explanation
<pre> ---LIGHT TIME--- INPUT: 20 UNIT: SEC           </pre>	<p>Press UP/DOWN to increase or decrease the input figure, confirm input and return back setup interface (refer to 6.4) by pressing ENTER button, press ESC button to cancel input and return back setup interface (refer to 6.4); the input numerical value is between 20 and 120.</p>

### 6.4.10 Date/time

Interface	Explanation
<pre> -----DATE/TIME----- DATE:2000-01-01 TIME: 02:43:03 WEEK: 6           </pre>	<p>Press UP/DOWN to increase or decrease the input figure; press ENTER button to move the cursor backwards, confirm input and return back setup interface (refer to 6.4); and move the cursor forward and return back setup interface (refer to 6.4) by pressing ESC button.</p>

### 6.4.11 History clearing

Interface	Explanation
<pre> --- DEL REC--- →1: CANCEL   2: CONFIRM           </pre>	<p>Clear all records in inquiry/record menu (refer to). Press UP/DOWN button to move corresponding options, and confirm the selected option and enter into setup interface (refer to 6.4) by pressing ENTER; press ESC button to cancel option and return back setup interface (refer to 6.4).</p>

### 6.4.12 Password setting

Interface	Explanation
<pre> ----- PASSWORD ----- OLD: XXXXX NEW:  XXXXX CONFIRM: XXXXX           </pre>	<p>This interface will be used to alter password when entering into the setup interface (refer to 6.4). Press UP/ DOWN to increase or decrease the input figure, press ENTER button to move the cursor backwards, confirm input and return back setup interface (refer to 6.4); and move the cursor forward and return back setup interface (refer to 6.4) by pressing ESC button.</p>

### 6.4.13 Maintenance

Interface	Explanation
<pre> -----PASSWORD----- INPUT:XXXXX           </pre>	<p>This interface will be used for factory testing, and be protected by password.</p>

### 6.6.14 Factory reset

Interface	Explanation
<pre> -FACTORY RESET- →1: CANCEL   2: CONFIRM           </pre>	<p>This interface will be used to reset inverter parameter to default. Press UP/DOWN button to move corresponding options, and confirm the selected option and enter into setup interface (refer to 6.4) by pressing ENTER; press ESC button to cancel option and return back setup interface (refer to 6.4).</p>

### 6.4.15 Array detection

Interface	Explanation
<pre> - ARRAY DETECT - →1: DETECT ENB   2: THRESHOLD           </pre>	<p>Press UP/DOWN button to move corresponding options, and confirm the selected option and enter into setup interface (refer to 6.4) by pressing ENTER; press ESC button to cancel option and return back setup interface (refer to 6.4).</p>

#### 6.4.15.1 ARRAY

Interface	Explanation
<pre> --ARRAY-- 1: ENABLE →2: DISABLE           </pre>	<p>Press UP/DOWN button to move corresponding options. And confirm selected option and return back Array detection by pressing ENTER button (refer to 6.4.15), press ESC button to cancel choice and return back Array detection (refer to 6.4.15);</p>

### 6.4.15.2 THRESHOLD

Interface	Explanation
<pre>--THRESHOLD-- INPUT:8A</pre>	<p>Press UP/DOWN to increase or decrease the input figure, confirm input and return back Array detection (refer to 6.4.15) by pressing ENTER button, press ESC button to cancel input and return back Array detection (refer to 6.4.15); the input numerical value is between 5 and 25.</p>

### 6.4.16 Three-phase system

Interface	Explanation
<pre>--Three-phase system-- 1:3W+N+PE →2:3W+PE</pre>	<p>According to the actual wiring mode ; Press UP/DOWN button to move corresponding options, and confirm the selected option and enter into setup interface (refer to 6.4) by pressing ENTER; press ESC button to cancel option and return back setup interface (refer to 6.4).</p>

## 6.5 Inquiry

Interface	Explanation
<pre>-----INQUIRE----- →1: INV MODEL 2: MODEL NO 3: FIRMWARE 4: RECORD</pre>	<p>Press UP/DOWN button to move the corresponding option, enter into the selected menu by pressing ENTER button; and return back the user interface (refer to 6.3) by pressing ESC button, there are 5 options in total, including INV MODEL, MODEL NO, FIRMWARE, RECORD And ERROR EVENT.</p>

### 6.5.1 INV MODEL

Interface	Explanation
<pre>-----INVERTER----- XXXXX</pre>	<p>This interface displays product Model of the inverter. UP/DOWN button is invalid, ENTER button is invalid; and press ESC button to return back the inquiry interface (refer to 6.5).</p>

### 6.5.2 MODEL SN

Interface	Explanation
<pre>-----INVERTER----- SN:</pre>	<p>This interface displays product series No. of the inverter. UP/DOWN button is invalid, ENTER button is invalid; and press ESC button to return back the inquiry interface (refer to 6.5).</p>

### 6.6.3 Firmware

Interface	Explanation
<pre>-----FIRMWARE----- ARM VER: I-DSP VER: B-DSP VER:</pre>	<p>This interface displays edition No. of firmware such as ARM and DSP in inverter. UP/DOWN button is invalid, ENTER button is invalid; and press ESC button to return back the inquiry interface (refer to 6.5).</p>

### 6.5.4 RECORD

Interface	Explanation
<pre>-----REC( 35)----- 1:F01-1 DATE: 2011-10-21 TIME: 16:35:26</pre>	<p>This interface displays record and its occurring time, including two types of fault and warning alarm, its content will be described in codes, with total number of 500 at utmost, after exceeding this extent, the one with earliest time will be covered. Press UP/DOWN button to look over record backwards or frontward, and press ENTER to enter into explanation interface for corresponding record content, as shown in the following Figure. Press ESC to return back inquiry interface (refer to 6.5).</p>

<pre>-----DETAIL----- Grid voltage High</pre>	<p>This interface will be used to reset inverter parameter to default. Press UP/DOWN button to move corresponding options, and confirm the selected option and enter into setup interface (refer to 6.4) by pressing ENTER; press ESC button to cancel option and return back setup interface (refer to 6.4).</p>
---	---

<pre>--- VALUE--- 285V</pre>	<p>This interface is used for displaying the corresponding specific numerical value when the code generates. For example, producing error code for high voltage value of commercial power, and we can refer to the voltage value of c at that that in this interface. Some codes correspond no numerical values, and then these interfaces are blank. If the voltage value is 999.9, it means that the voltage and current of the power grid have a shock protection. UP/ DOWN button is invalid, and ENTER is also invalid; press ESC button to return back the last interface.</p>
------------------------------	--

### 6.5.5 ERROR EVENT

Interface	Explanation
<pre>-----EVE( 20)----- 1:F01-1 Date: 2011-10-21 Time: 16:35:26</pre>	<p>Press UP/DOWN button to look over record backwards or frontward, and press ENTER to enter into explanation interface for corresponding record content, as shown in the following Figure. Press ESC to return back inquiry interface (refer to 6.5).</p>

<pre>--EVE( 1)-- +BUS: 350.0V -BUS: 350.0V RADIATOR: 50°C</pre>	<p>Press UP/DOWN button to look over record backwards or frontward, press ESC button to return back the last interface.</p>
---	---

```
--EVE(1)--
RS: 0.00Hz
ST: 0.00Hz
TR: 0.00Hz
```

Press UP/DOWN button to look over record backwards or frontward, press ESC button to return back the last interface.

```
--EVE(1)--
RS: 0.00V
ST: 0.00V
TR: 0.00V
```

Press UP/DOWN button to look over record backwards or frontward, press ESC button to return back the last interface.

## 6.6 Statistics

Interface	Explanation
<pre>----- STAT. ----- →1:TIME STAT. 2:CONNE.TIMES 3:PEAK POWER</pre>	<p>This interface is used to select various options for statistics. UP/DOWN button is used to move corresponding options, press ENTER button to enter the selected menu; and press ESC to return back the user interface (refer to 6.3), there are 8 options, including time, networking number, total, that day, that week, that month, that year, power peak.</p>

### 6.6.1 Time statistics

Interface	Explanation
<pre>-----TIME----- RUN: 86 GRID: 56 UNIT: HOUR</pre>	<p>This interface displays operational time and generating duration of the inverter. UP/DOWN button is invalid, and ENTER is also invalid; press ESC button to return back statistics interface (refer to 6.6).</p>

### 6.6.2 Times of paralleling in

Interface	Explanation
<pre>--CONNE.TIMES-- TIMES: 45</pre>	<p>This interface displays times of paralleling in for the inverter. UP/ DOWN button is invalid, and ENTER is also invalid; press ESC button to return back statistics interface (refer to 6.6).</p>

### 6.6.3 Power peak

Interface	Explanation
<pre>--PEAK POWER-- HISTORY:10645 TODAY: 9600 UNIT: W</pre>	<p>This interface displays history power peak and today power peak of the inverter. UP/DOWN button is invalid, and ENTER is also invalid; press ESC button to return back statistics interface (refer to 6.6).</p>

### 6.6.4 Generated energy of that day

Interface	Explanation
<pre>-----E-TODAY----- NUM: 100 UNIT: KWH</pre>	<p>This interface displays generated energy of that day. Refresh after 24 o'clock, inverter time should be set in different time zones. UP/DOWN button is invalid, and ENTER is also invalid; press ESC button to return back statistics interface (refer to 6.6).</p>

### 6.6.5 Generated energy of that week

Interface	Explanation
<pre>-----E-WEEK----- NUM: 700 UNIT: KWH</pre>	<p>This interface displays generated energy of that day. UP/DOWN button is invalid, and ENTER is also invalid; press ESC button to return back statistics interface (refer to 7.6).</p>

### 6.6.6 Generated energy of that month

Interface	Explanation
<pre>-----E-MONTH----- NUM: 3000 UNIT: KWH</pre>	<p>This interface displays generated energy of that month. UP/DOWN button is invalid, and ENTER is also invalid; press ESC button to return back statistics interface (refer to 6.6).</p>

### 6.6.7 Generated energy of that year

Interface	Explanation
<pre>-----E-YEAR----- NUM: 30000 UNIT: KWH</pre>	<p>This interface displays generated energy of that year. UP/DOWN button is invalid, and ENTER is also invalid; press ESC button to return back statistics interface (refer to 6.6).</p>

### 6.6.8 Gross generation

Interface	Explanation
<pre>-----E-TOTAL----- NUM: 100000 UNIT: KWH</pre>	<p>This interface displays gross generation of the inverter. UP/DOWN button is invalid, and ENTER is also invalid; press ESC button to return back statistics interface (refer to 6.6).</p>

## 07 Maintenance

Inverter does not require any regular maintenance. However, cleaning the dust on heat-sink will help the inverter to dissipate the heat and increase its life time. The dust can be removed with a soft brush.



### CAUTION:

Do not touch the inverter's surface when it is operating. Some parts of the inverter may be hot and cause burns. Turn off the inverter (refer to Section 5.2) and wait for a cool-down period before any maintenance or cleaning operation.

The LCD and the LED status indicator lights can be cleaned with a damp cloth if they are too dirty to be read.



### NOTE:

Never use any solvents, abrasives or corrosive materials to clean the inverter.

## 08 Trouble shooting

It is very easy for the inverter's maintenance. When you meet any problems, please refer to the following trouble shooting first, please contact your local distributor if the problem can't be solved by yourself.

The following sheet lists some basic questions may encounter in the operation.

Alarm Message	Failure description	Solution
F00-F03	AC voltage & frequency are too high or too low.	<ol style="list-style-type: none"> <li>1. Please check mains voltage whether it is complied with local, safety standard</li> <li>2. Please check the AC output line is properly connected. Make sure its output voltage to see if it is normal.</li> <li>3. Disconnect PV input and restart the inverter and check whether.</li> <li>4. If the power grid is normal, the fault is still reported. Please contact the dealer.</li> </ol>
F04-F05	Bus voltage is too high or too low.	<ol style="list-style-type: none"> <li>1. Please check the setting of input mode</li> <li>2. Disconnect PV input and restart the inverter and check whether fault still exists, Please contact the dealer..</li> </ol>
F06	Bus voltage is Unbalance	<ol style="list-style-type: none"> <li>1. Please check the setting of input mode.</li> <li>2. Disconnect PV input and restart the inverter and check whether fault still exists.</li> <li>3. The fault still exists after the restart. Please contact the dealer</li> </ol>
F07	Insulation impedance Fault	<ol style="list-style-type: none"> <li>1. Disconnect PV input and restart the inverter and check whether fault still exists.</li> <li>2. Please measure impedance of PV+/PV- to ground whether is over than 50KΩ.</li> <li>3. The insulation of the series is normal but the fault still exists. Please contact the dealer.</li> </ol>
F08	Input Current High	<ol style="list-style-type: none"> <li>1. Please check the setting of input mode.</li> <li>2. Disconnect PV input and restart the inverter and check whether fault still exists.</li> </ol>
F09	Hardware Current High	<ol style="list-style-type: none"> <li>1. Disconnect PV input and restart the inverter after few minutes and check whether fault still exists.</li> </ol>
F10	Inverter Current High	<ol style="list-style-type: none"> <li>1. Disconnect PV input and restart the inverter after few minutes and check whether fault still exists.</li> </ol>
F11	Inverter DC Current high	<ol style="list-style-type: none"> <li>1. Disconnect PV input and restart the inverter after few minutes and check whether fault still exists.</li> </ol>

Alarm Message	Failure description	Solution
F12	Amb Temperature Over	<ol style="list-style-type: none"> <li>1.Disconnect PV input and cool down the inverter then restart the inverter to see if it is back to normal operation.</li> <li>2.Please check environmental temperature whether out of working temperature.</li> </ol>
F13	Heatsink Temperature High	<ol style="list-style-type: none"> <li>1.Disconnect PV input and cool down the inverter then restart the inverter to see if it is back to normal operation.</li> <li>2.Please check environmental temperature whether out of working temperature.</li> </ol>
F14	AC Relay Fault	<ol style="list-style-type: none"> <li>1.Disconnect PV input and restart the inverter and check whether fault still exists.</li> <li>2. Check whether the phase line is missing phase, such as R, S, T phase.</li> </ol>
F15	PV Input Voltage Low	<ol style="list-style-type: none"> <li>1.Please check the configuration of PV input, one of PV input is idle when inverter is set on parallel mode.</li> <li>2.Disconnect the PV input and restart the inverter and check whether fault still exists.</li> </ol>
F16	Remote Off	<ol style="list-style-type: none"> <li>1.The inverter is on remote OFF status, the Inverter can be turned,off/on remotely by monitoring software.</li> </ol>
F18	SPI communication Fault	<ol style="list-style-type: none"> <li>1.Disconnect PV input and restart the inverter and check whether fault still exists.</li> </ol>
F20	Leakage Current High	<ol style="list-style-type: none"> <li>1.Disconnect PV input and restart the inverter and check whether fault still exists.</li> <li>2. Check whether the AC cable and PV input line have abnormal insulation.</li> </ol>
F21	Leakage Current Self-Checking Failure	<ol style="list-style-type: none"> <li>1.Disconnect PV input and restart the inverter and check whether fault still exists.</li> <li>2.Contact with your local distributor if the fault still exists.</li> </ol>
F22	Consistency Voltage Fault	<ol style="list-style-type: none"> <li>1.Disconnect PV input and restart the inverter and check whether fault still exists.</li> <li>2.Contact with your local distributor if the fault still exists.</li> </ol>

Alarm Message	Failure description	Solution
F23	Consistency Frequency Fault	<ol style="list-style-type: none"> <li>1.Disconnect PV input and restart the inverter and check whether fault still exists.</li> <li>2.Contact with your local distributor if the fault still exists.</li> </ol>
F24	DSP Operation Fault	<ol style="list-style-type: none"> <li>1.Disconnect PV input and restart the inverter and check whether fault still exists.</li> <li>2.Contact with your local distributor if the fault still exists.</li> </ol>
F26	IGBT Fault	<ol style="list-style-type: none"> <li>1.Disconnect PV input and restart the inverter and check whether fault still exists.</li> <li>2.Contact with your local distributor if the fault still exists.</li> </ol>
F27	NPE Volte Fault	<ol style="list-style-type: none"> <li>1. Measure whether the voltage between N line and PE is abnormal greater than 36V;</li> <li>2. Modify the NPE detection voltage limit value or turn off the NPE detection function.</li> </ol>
F32	DSP communication Lost	<ol style="list-style-type: none"> <li>1.Disconnect PV input and restart the inverter and check whether fault still exists.</li> <li>2.Contact with your local distributor if the fault still exists.</li> </ol>
W00	Fan A Lock	<ol style="list-style-type: none"> <li>1.Disconnect PV input and restart the inverter and check whether fault still exists.</li> <li>2.Contact with your local distributor if the fault still exists.</li> </ol>
W01	Fan B Lock	<ol style="list-style-type: none"> <li>1. Check whether there is foreign matter blocking the fan blade, causing the fan to not rotate normally ;</li> <li>2.Disconnect PV input and restart the inverter and check whether fault still exists ;</li> <li>3.Contact with your local distributor if the fault still exists.</li> </ol>

Alarm Message	Failure description	Solution
W02	Fan C Lock	<ol style="list-style-type: none"> <li>1. Check whether there is foreign matter blocking the fan blade, causing the fan to not rotate normally;</li> <li>2. Disconnect PV input and restart the inverter and check whether fault still exists;</li> <li>3. Contact with your local distributor if the fault still exists.</li> </ol>
W03	Zero Power	<ol style="list-style-type: none"> <li>1. Check whether there is foreign matter blocking the fan blade, causing the fan to not rotate normally;</li> <li>2. Disconnect PV input and restart the inverter and check whether fault still exists.</li> <li>3. Contact with your local distributor if the fault still exists.</li> </ol>
W04	Array Warning	<ol style="list-style-type: none"> <li>1. Check whether the input string is unbalanced;</li> <li>2. Set the limit value of string detection according to the number of access strings.</li> </ol>
W05	Reserved Bite	<ol style="list-style-type: none"> <li>1. Check whether there is a heat source in the accessories of the inverter, causing the inverter to overheat and reduce power.</li> <li>2. Check whether the inverter maintains air circulation.</li> </ol>
W06	Lightning Warning	<ol style="list-style-type: none"> <li>1. Disconnect PV input and restart the inverter and check whether fault still exists.</li> <li>2. Contact with your local distributor if the fault still exists.</li> </ol>
W19	Fan D Lock	<ol style="list-style-type: none"> <li>1. Disconnect PV input and restart the inverter and check whether fault still exists.</li> <li>2. Contact with your local distributor if the fault still exists.</li> </ol>

▲ Table 8.1 Trouble shooting



**NOTE:**

If the inverter displays any alarm message as listed in Table 8.1; please turn off the inverter (refer to Section 5.2 to stop your inverter) and wait for 5 minutes before restarting it (refer to Section 5.1 to start your inverter). If the failure persists, please contact your local distributor or the service center. Please keep ready with you the following information before contacting us.

1. Serial number of Inverter;
2. The distributor/dealer of Inverter (if available);
3. Installation date.
4. The description of problem (i.e. the alarm message displayed on the LCD and the status of the LED status indicator lights. Other readings obtained from the Information submenu will also be helpful.) ;
5. The PV array configuration (e.g. number of panels, capacity of panels, number of strings ,etc.);
6. Your contact details.

## 09 Specifications

Model Specifications	BluE-12KTL-M1	BluE-15KTL-M1	BluE-20KTL-M2
<b>Input(DC)</b>			
Max. DC voltage	800V		
Max. input current per MPPT tracker	30A		
PV short circuit current	40A		
Start Voltage	180V		
MPPT voltage range	200-750V		
Full load MPPT voltage range	260-600V	300-600V	300-600V
Nominal Voltage	370V		
Number of MPPT trackers	2		
Strings per MPPT tracker	2		
<b>Output(AC)</b>			
Normal AC output Power	12kW	15kW	20kW
Rated Apparent Power	13.2kVA	16.5kVA	22kVA
Max. AC output Power	13.2kW	16.5kW	22kW
Normal AC voltage	400V/230V		
Normal AC grid frequency	50Hz/60Hz		
Nominal output current	31.5A	39.3A	52.5A
Max. output current	34.6A	43.3A	57.7A
Power Factor( $\Phi$ )	-0.8~+0.8		
THDi	3%		
<b>Efficiency</b>			
Max. Efficiency	98.6%		
Euro Efficiency	97.3%		
<b>General Specifications</b>			
Dimensions (W / L / D)	380*483*227mm		
Weight(KG)	32.5	25.2	32.5
Operating temperature range	-25°C ~ +60°C		
Cooling Type	Natural Cooling		
Max. Operation Altitude	4000m ( > 3000m derating )		
Max. Operation Humidity	0~100%		
IP Class	IP66		
Topology	Transformer-less		
<b>Display and communication</b>			
Display	LCD		
RS485	2		

## 09 Specifications

<b>Protection devices</b>	
DC Switch	Yes
Output Over Current	Yes
Anti-islanding Protection	Yes
DC Reverse Polarity Protection	Yes
String Fault Detection	Yes
AC/DC Surge Protection	DC: Type II / AC: Type III / Type II Optional
Insulation Detection	Yes
AC Short Circuit Protection	Yes
<b>Other functions</b>	
Anti-reflux	Support, need to select distribution table
PID recovery	Optional
IV scan	Yes
Remote upgrade	Yes
<b>Authentication</b>	
Safety regulations	"EN/IEC 62109-1_2010 ; EN/IEC 62109-2_2011"
EMC	EN/IEC 61000-6-1/2/3/4 ; EN/IEC 61000-3-11/12
Performance	IEC 60068 ; IEC 60529 ; IEC62116 ; IEC61727
Grid standards	NB32004-2018,EN50549-1,VDE-AR-N-4105-2018 VDE124,VDE126,CEI-021,C10/C11,G98/G99

Table 9.1 Grid Specification(3W+N+PE)

Grid Specification	Output Voltage Range (Vac)	Output Frequency Range (Hz)	Boot wait time(S)	Error recovery time (S)
China	187 - 252	48 - 50.5	60	30
Germany	196 - 264	47.5 - 51.5	60	30
Australia	200 - 270	48 - 52	60	30
Italy	184 - 276	49.7 - 50.3	60	30
Spain	196 - 253	48 - 50.5	180	30
U.K.	184 - 264	47 - 52	180	30
Hungary	198 - 253	49.8 - 50.2	300	30
Belgium	184 - 264	47.5 - 51.5	60	30
AUS-W	200 - 270	47.5 - 50.5	60	30
Greece	184 - 264	49.5 - 50.5	180	30
France	184 - 264	47.5 - 50.4	60	30
Metro	200 - 240	49 - 51	60	30
Thailand	198 - 242	48 - 51	60	30
GB19964	184 - 276	48 - 52	60	30
Local	184 - 276	45 - 55	60	30
60Hz	184 - 276	58 - 62	60	30
LV50Hz	101.6-139.7	57.5-62	60	30
LV60Hz	101.6-139.7	57.5-62	60	30

Table 9.2 Grid Specification(3W+PE/LL)

Grid Specification	Output Voltage Range (Vac)	Output Frequency Range (Hz)	Boot wait time(S)	Error recovery time (S)
China	340 - 480	48 - 50.5	60	30
Germany	340 - 460	47.5 - 51.5	60	30
Australia	340 - 480	48 - 52	60	30
Italy	320 - 480	49.7 - 50.3	60	30
Spain	340 - 440	48 - 50.5	180	30
U.K.	320 - 460	47 - 52	180	30
Hungary	360 - 440	49.8 - 50.2	300	30
Belgium	320 - 460	47.5 - 51.5	60	30
AUS-W	340 - 480	47.5 - 50.5	60	30
Greece	320 - 460	49.5 - 50.5	180	30
France	320 - 460	47.5 - 50.4	60	30
Metro	346 - 416	49 - 51	60	30
Thailand	342 - 418	48 - 51	60	30
GB19964	320 - 480	48 - 52	60	30
Local	320 - 480	45 - 55	60	30
60Hz	320 - 480	58 - 62	60	30
LV50Hz	176- 242	57.5 - 62	60	30
LV60Hz	176- 242	57.5 - 62	60	30

## 10 Quality Assurance

When product faults occur during the warranty period, KSTAR or his partner will provide free service or replace the product with a new one.

### Evidence

During the warranty period, the customer shall provide the product purchase invoice and date. In addition, the trademark on the product shall be undamaged and legible. Otherwise, KSTAR has the right to refuse to honor the quality guarantee.

### Conditions

- After replacement, unqualified products shall be processed by KSTAR.
- The customer shall give KSTAR or his partner a reasonable period to repair the faulty device.

### Exclusion of Liability

In the following circumstances, KSTAR has the right to refuse to honor the quality guarantee:

- The free warranty period for the whole machine/components has expired.
- The device is damaged during transport.
- The device is incorrectly installed, refitted, or used.
- The device operates in harsh environment, as described in this manual.
- The fault or damage is caused by installation, repairs, modification, or disassembly performed by a service provider or personnel not from KSTAR or his authorized partner.
- The fault or damage is caused by the use of non-standard or non-KSTAR.

### components or software.

- The installation and use range are beyond stipulations of relevant international standards.
- The damage is caused by unexpected natural factors.

For faulty products in any of above cases, if the customer requests maintenance, paid maintenance service may be provided based on the judgment of KSTAR.

## 11 Contact Information

18 overseas branch offices



☎ PV inverter industry Pre-sales : (86)0755-89741234 Ext 8151

☎ PV inverter industry After-sales : (86)0755-89741234 Ext 8729

✉ Global overseas service mailbox : [overseas\\_service@kstar.com.cn](mailto:overseas_service@kstar.com.cn)